

**NEW PRODUCT
AVAILABLE**

HAND-HELD PRINTER

Any angel at any
time



Distributor unic in Romania

Mival
group
(We've learned to respect your money)

Mival Group SRL
Ploiesti, Str. Laboratorului, Nr. 31
100301, Romania
Tel./Fax. : 0244 59 68 10
Email : office@mival.ro

MASTER UNLIMITED INKJET IN ONE HAND

Light

Super light

Super light printer weight
only 430g

600dpi

600dpi(Hd version)

Can print high-quality text,
graphics and a variety of bar
codes, resolution up to 600 dpi

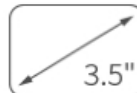

Extra large display

3.5 inches Capacitive touch
screen, easy and smooth
operation



Built-in large capacity

Mass storage and
backup printing date,
easily upgrade software



Plug and work inkjet cartridge

Completely maintenance-free
Drastically reduce nozzle repair
and stop-line costs



Ink automatic identification

Automatically detect different inks
and adjust the best parameters
to ensure superb print quality

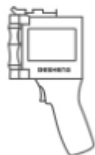

Unlimited printing

Spurt the code anywhere at 360 degrees
without ink-leaking



Long-lasting battery

Continuous printing up to 7 hours, more than
200,000 characters

Distributor unic in Romania

Mival
group
(We've learned to respect your money)

Mival Group SRL
Ploiesti, Str. Laboratorului, Nr. 31
100301, Romania
Tel./Fax. : 0244 59 68 10
Email : office@mival.ro

HANDHELD PRINTER SPECIFICATIONS



Distribuitor unic in Romania

Mival
group
[We've learned to respect your money]

Mival Group SRL
Ploiesti, Str. Laboratorului, Nr. 31
100301, Romania
Tel./Fax. : 0244 59 68 10
Email : office@mival.ro

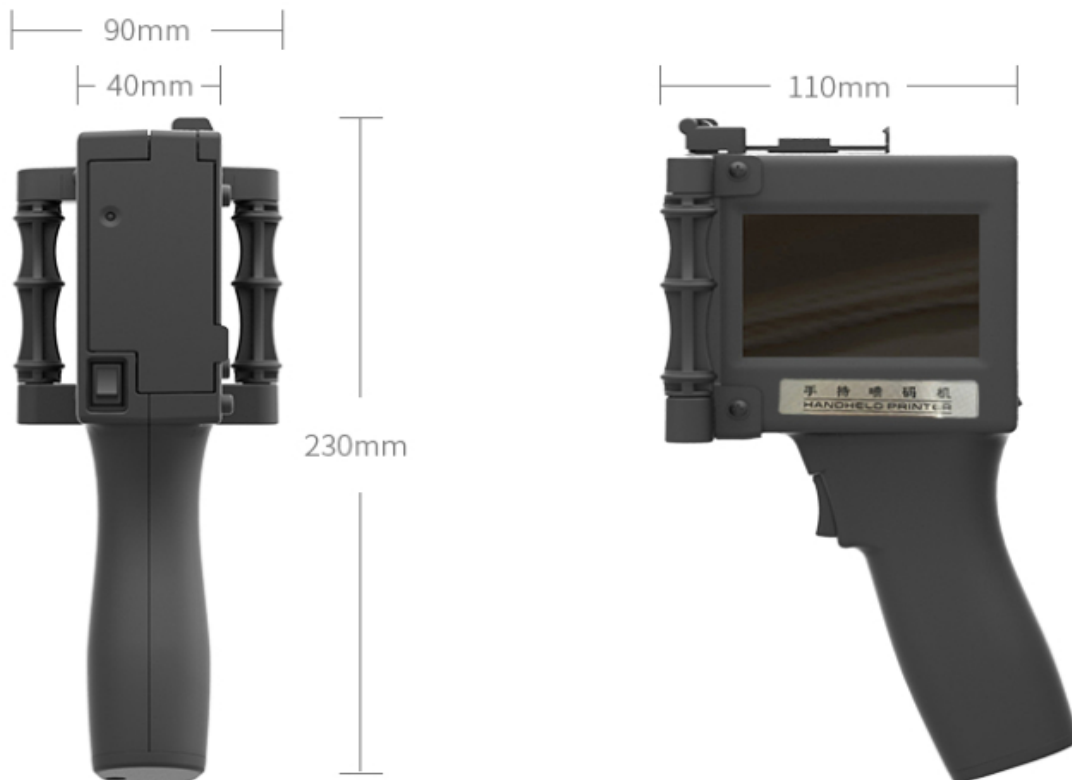

Display screen: 3.5-inch color large LCD screen

Status display: LED green for the power light, blue means under printing, red for insufficient power

Operation interface: Digital selection menu, operation easily

Spray print content: Chinese, English, digit, symbol, QR code, Bar code, picture, time, date, calculator.

support material: block board, carton, stone, Medium Density fiberboard, Lightgag Steel Joist, tube, metal, plastic, aluminium foil, cable etc

support font: high definition print font, many Chinese and English fonts inside

Printing graphics: can spray a variety of trademark patterns, graphics can be imported from the U disk

Print precision: standard 300dpi, premium 600 dpi, bolding

Print lines: one to seven lines adjustable

Font height: can print 2mm ~ 13mm (adjustable)

Printing distance: 2-5mm (nozzle and spray object distance)

Print speed: at the level of 300 DPI conditions, up to 76m / min

Print direction: 360 degrees.

Sequence number: 1 ~ 8 variable

Distribuitor unic in Romania



Mival Group SRL
 Ploiesti, Str. Laboratorului, Nr. 31
 100301, Romania
 Tel./Fax. : 0244 59 68 10
 Email : office@mival.ro

SUPPORT MATERIALS

Wood, carton, plastic, film, food, glass, steel tube, etc.



plastic



carton



glass



wood



steel tube



MORE

Distribuitor unic in Romania

Mival
group
[We've learned to respect your money]

Mival Group SRL
Ploiesti, Str. Laboratorului, Nr. 31
100301, Romania
Tel./Fax. : 0244 59 68 10
Email : office@mival.ro

INK TYPE

Normal water-base ink

normal ink for paper, carton and water-absorbing materials;

solvent ink

solvent ink for plastic, glass, Metal, tube, stone, block board, Medium Density fiberboard, aluminium foil, cable, film etc.

Ink color: black, red, blue, yellow, green, white.

Cartridge capacity: 45 ml.

USB port.

Battery capacity: 2600 mAh.

Stand-by time: 20 hours.

System Power consumption: average below 5w.

environment temperature: 0 ~ 40, humidity: 10% ~ 80%.

Power: DC8.4V-2A, lithium battery stand by time: 15 hours, print 7 hours.

Weight: 550 g (include the ink and the battery)

Data storage capacity: more than 1000MB.

Continuous Print time: more than 7 hours.

Size (length*width*height: mm):110*40(90 include the roller)*230

Distributor unic in Romania



Mival Group SRL
Ploiesti, Str. Laboratorului, Nr. 31
100301, Romania
Tel./Fax. : 0244 59 68 10
Email : office@mival.ro

FEATURES OF THE HAND-HELD PRINTER

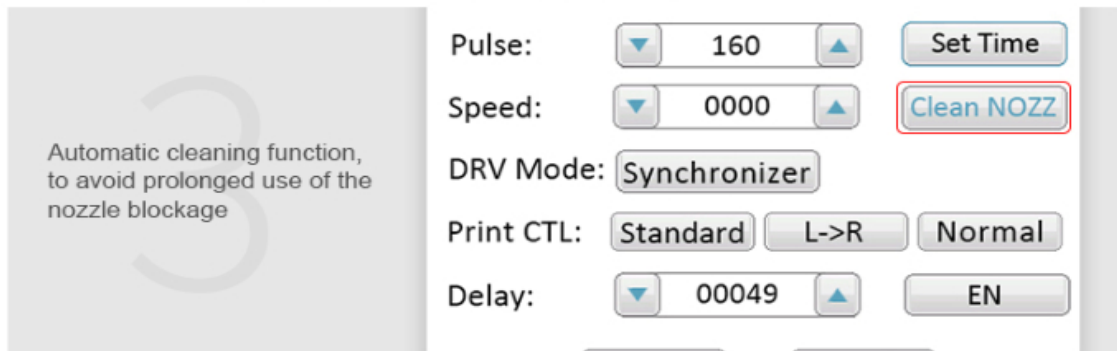

Distribuitor unic in Romania



Plug and work inkjet cartridge
Completely maintenance-free
Drastically reduce nozzle repair
and stop-line costs



Automatic power-saving function,
standby mode, the screen automatically
dark after 60 seconds



Built-in high capacity FLASH
can storage backup printing
information, and easily
upgrades software



Capacitive touch screen panel,
3.5-inch full-screen operating
system, accurate and convenient
touch screen operation

Distributor unic in Romania

DISPLAY DIAGRAM OF THE SPREADER



front side



right side



left side

ACCESSORIES



Power adapter



ink cartridge



packing box

Distribuitor unic in Romania

Mival
group
(We've learned to respect your money)

Mival Group SRL
Ploiesti, Str. Laboratorului, Nr. 31
100301, Romania
Tel./Fax. : 0244 59 68 10
Email : office@mival.ro

HOW TO PRINT TIME AND DATE

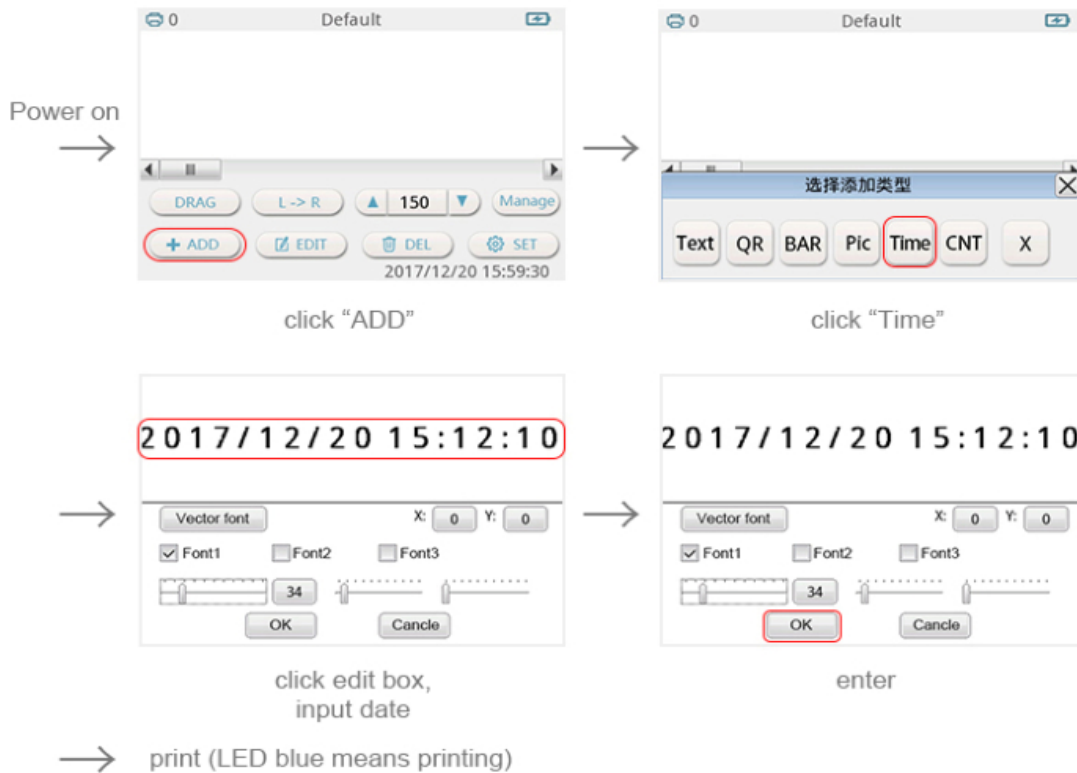

Distribuitoar unic in Romania

HOW TO IMPORT PICTURE

Picture → modify picture
(format:*.bmp; *.dib; size:800mm*150mm; → insert U disk → power on
color: monochrome)



click "ADD"

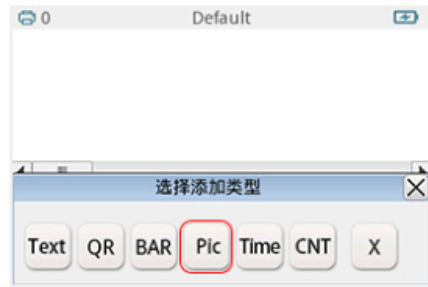

click "Pic"



refresh

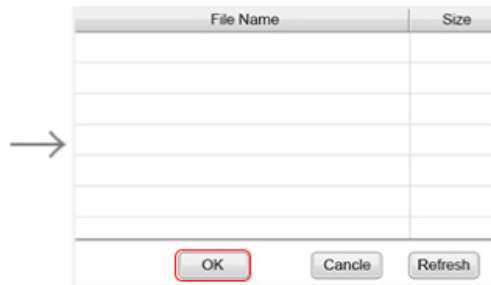

enter

→ choose picture → click " selected picture"
(adjust height and width)

→ print (LED blue means printing)

Distributor unic in Romania

REAL PICTURE



Distributor unic in Romania



Mival Group SRL
 Ploiesti, Str. Laboratorului, Nr. 31
 100301, Romania
 Tel./Fax. : 0244 59 68 10
 Email : office@mival.ro